

Magnetisme

- **Magnetostatikk** (ingen tidsvariasjon): $\partial \mathbf{B} / \partial t = 0$
- Kap 27. Magnetiske krefter
- Kap 28: Magnetiske kilder

- **Elektrodynamikk (tidsvariasjon):**
- Kap 29: Elektromagnetisk induksjon $\partial \mathbf{B} / \partial t \neq 0$
- Kap 30: Induktans
- Kap 31: Vekselstrømskretser
- Kap 32: Elektromagnetiske bølger

FARADAY'S PARADOX

This is a coil of wire with a hunk of iron locked in it.



- a) If current is made to flow in the wire, the iron becomes a magnet
- b) If the iron is a magnet, current is made to flow in the wire
- c) Both of the first two statements are true
- d) Both of the first two statements are false

Michael Faraday (eng. 1791-1867) og
Joseph Henry (amer. 1797-1878):

1832: Strøm produseres ved **induksjon**:

Flere muligheter for induksjon:

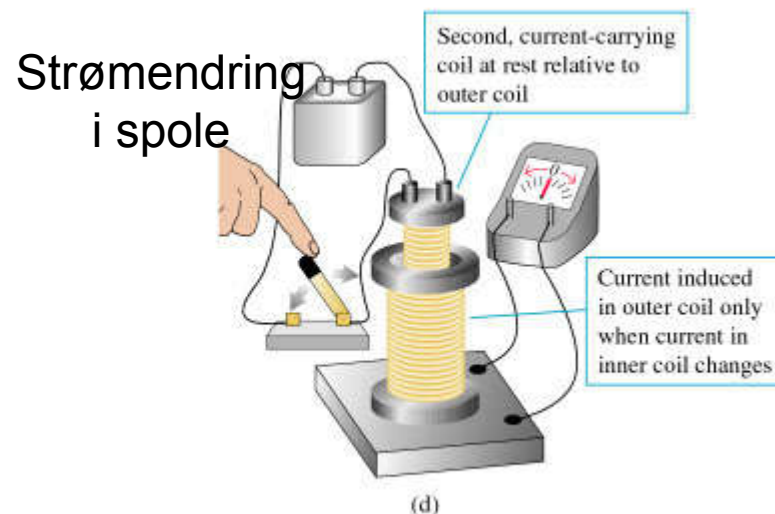
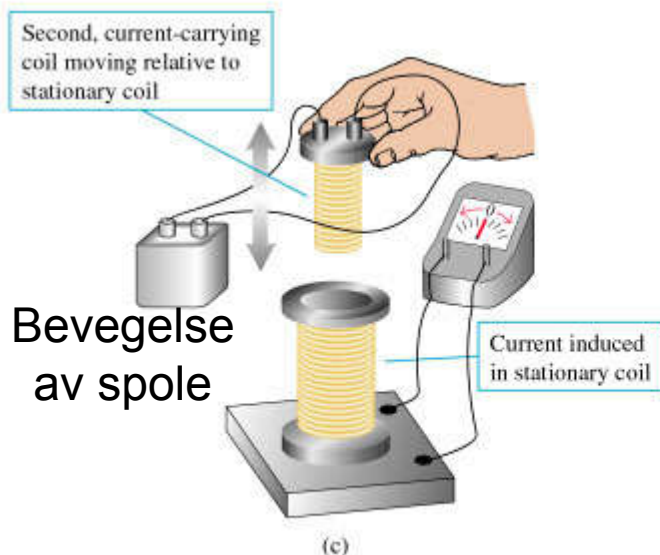
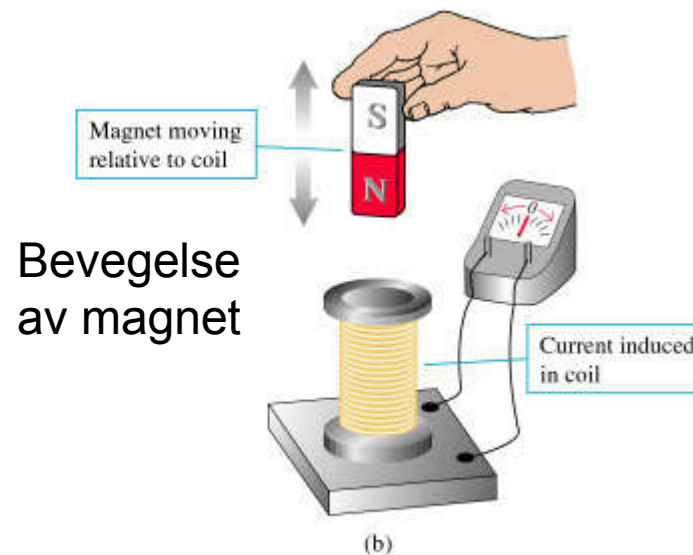
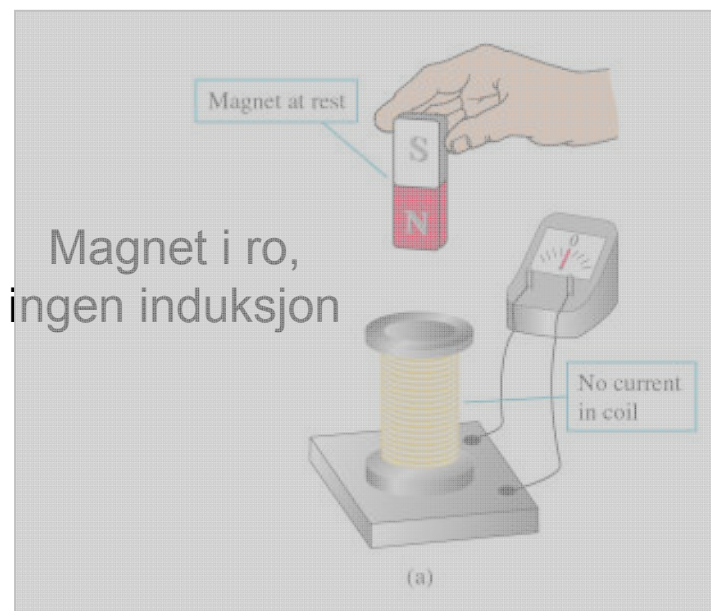

Faradays lov:

Indusert ems: $\mathcal{E} = - d\Phi_B/dt$, der $\Phi_B = \iint \mathbf{B} \cdot d\mathbf{A}$

eller indusert \mathbf{E} -felt: $\int \mathbf{E} \cdot d\mathbf{s} = - d\Phi_B/dt$

Homogen \mathbf{B} og plan strømsløyfe:

$$\Phi_B = B A \cos\varphi = \boxed{B(t)} \cdot A(t) \cdot \cos\varphi(t)$$

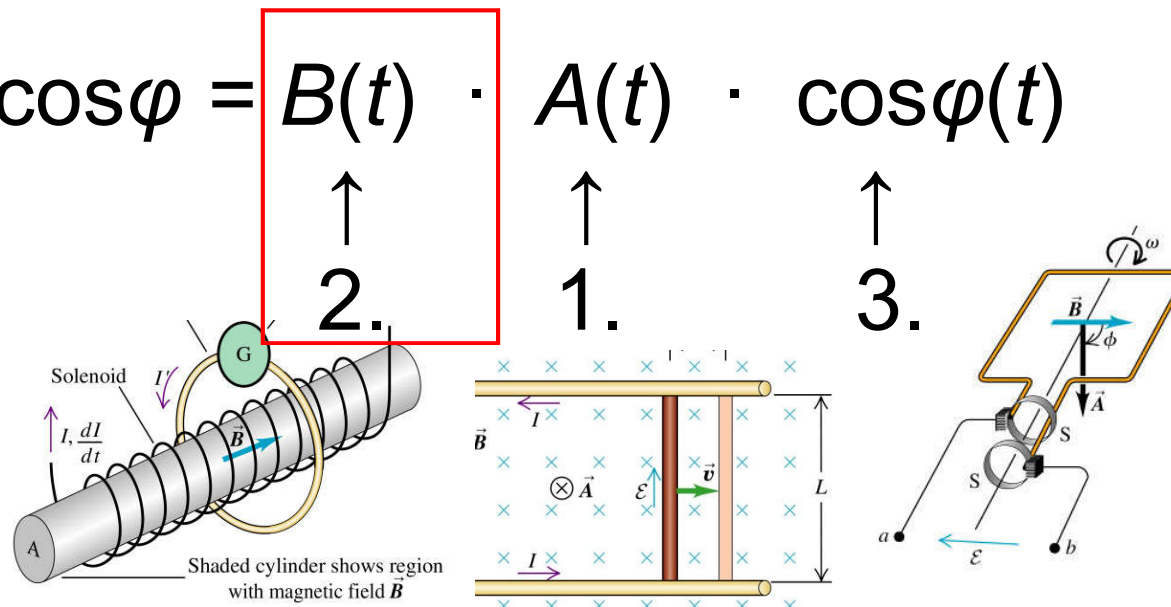

Bevis av Faradays lov:

1. Endring $A(t)$:

$$\mathcal{E} = - d\Phi_B/dt = - B \cdot dA(t)/dt \cdot \cos 0^\circ$$

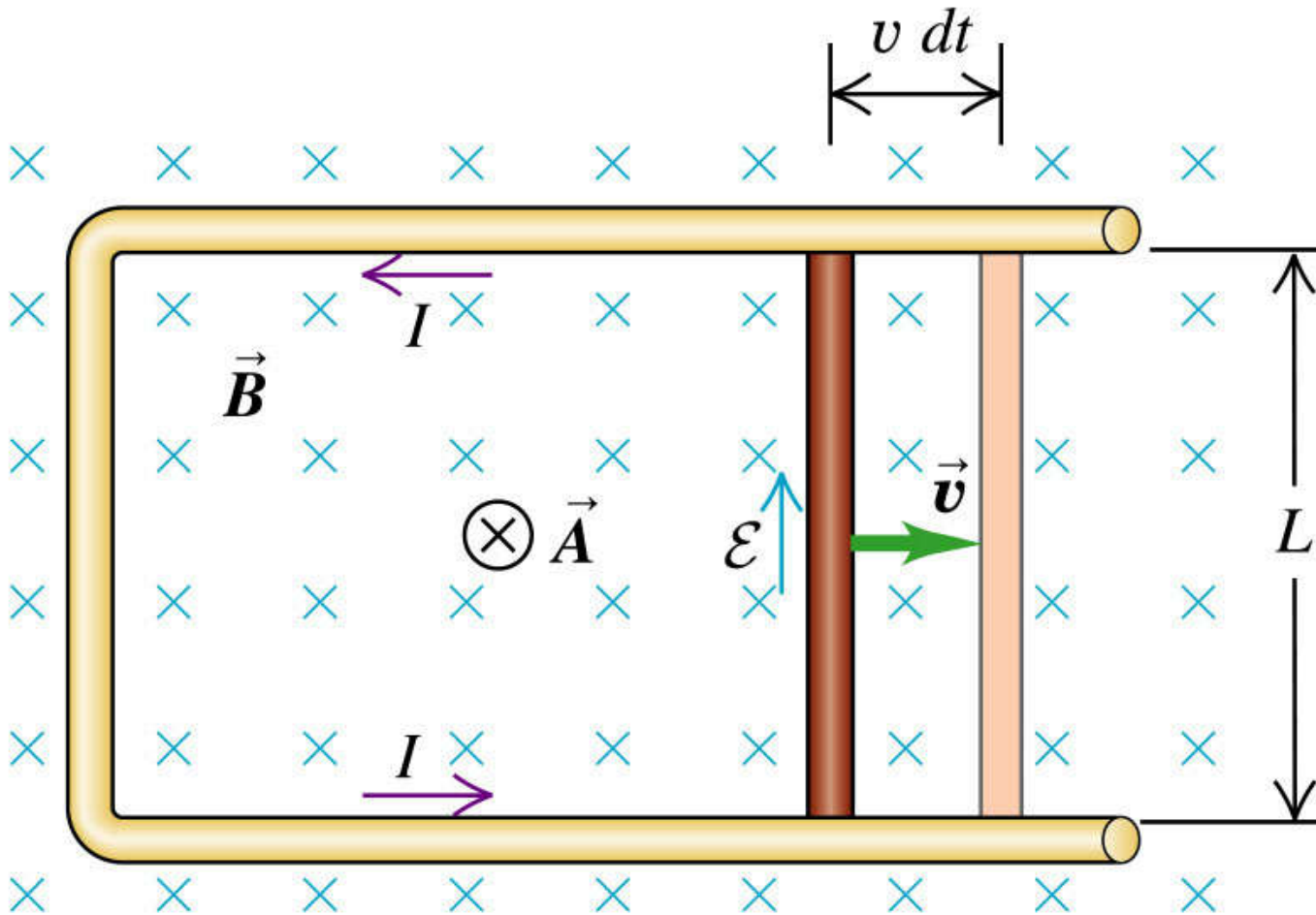

(Fig 29.11)

Induksjon: Lenz' lov

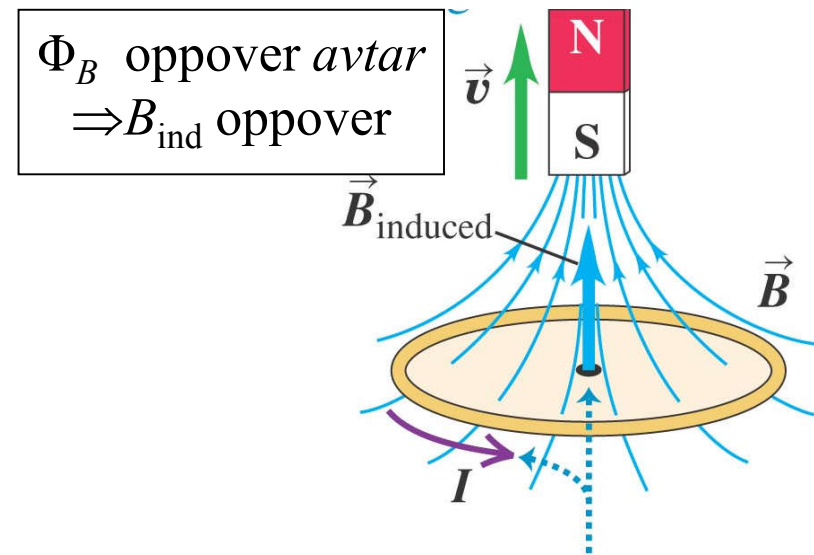
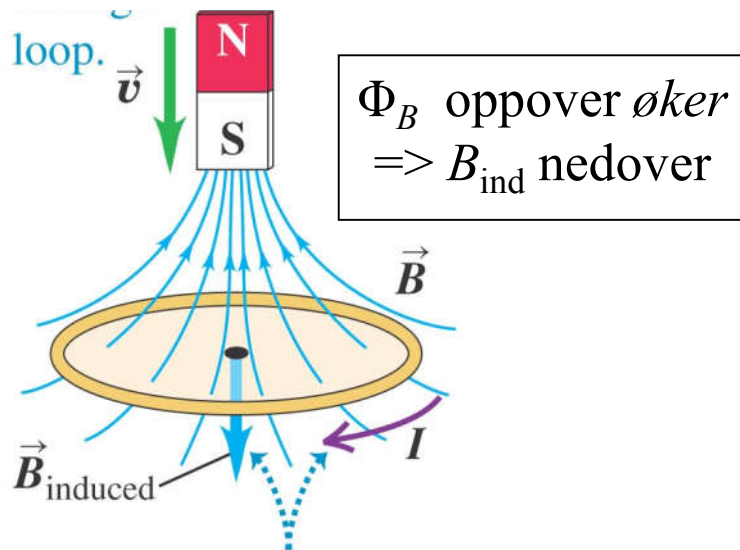
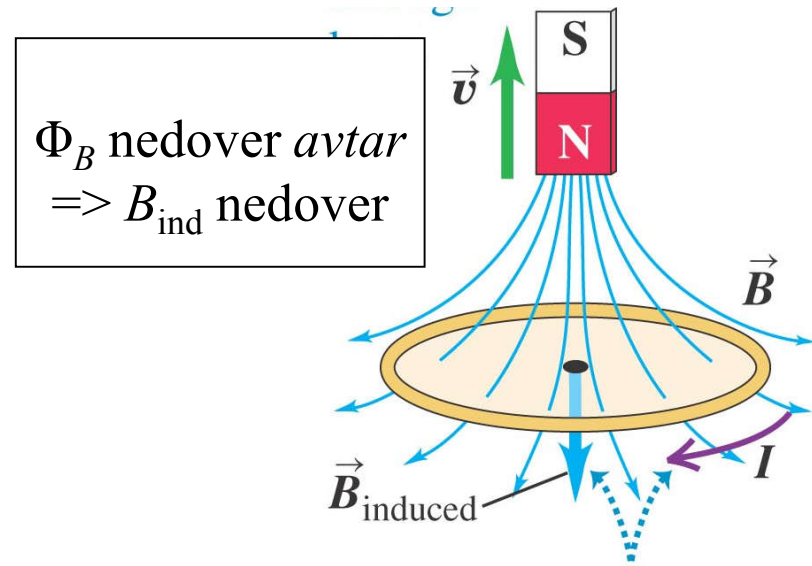
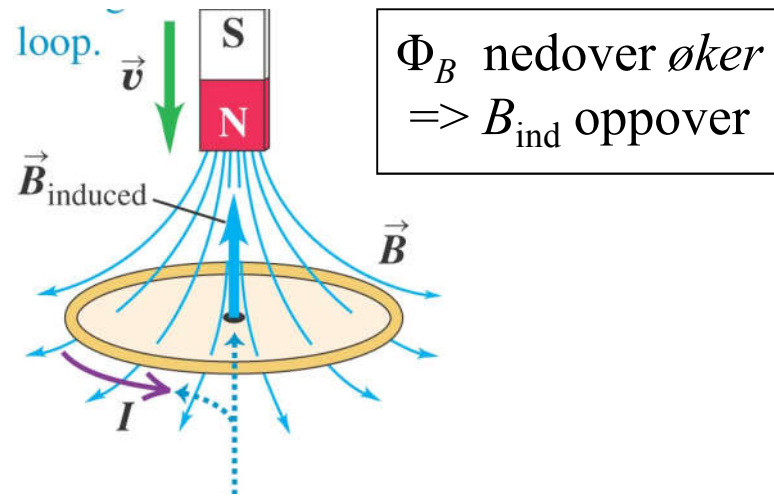

(Fig 29.14)

Le Chateliers prinsipp:

Et system i likevekt som påtvinges en endring: Systemet reagerer med å motvirke endringen.

(naturen er konservativ)

Faradays lov:

2. Endring $B(t)$:

Indusert e.m.s: $\mathcal{E} = - d\Phi_B/dt = - dB(t)/dt \cdot A \cdot \cos 0^\circ$

bedre: indusert \vec{E} -felt: $\int \vec{E} \cdot d\vec{s} = - d\Phi_B/dt$

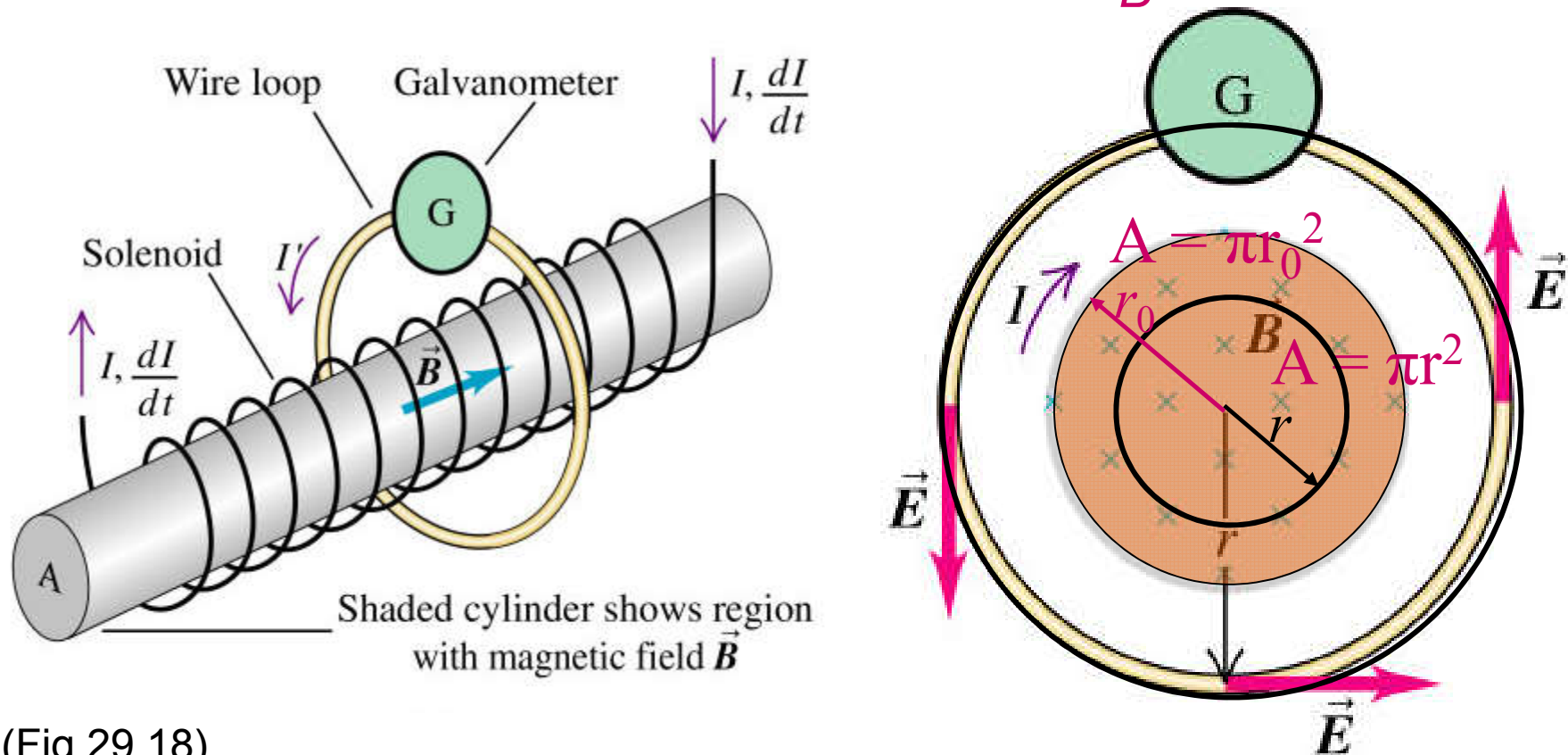

(Fig 29.18)

Faradays lov:

3. Endring $\varphi(t)$:

$$\mathcal{E} = - d\Phi_B/dt = - B \cdot A \cdot d(\cos \varphi) /dt$$

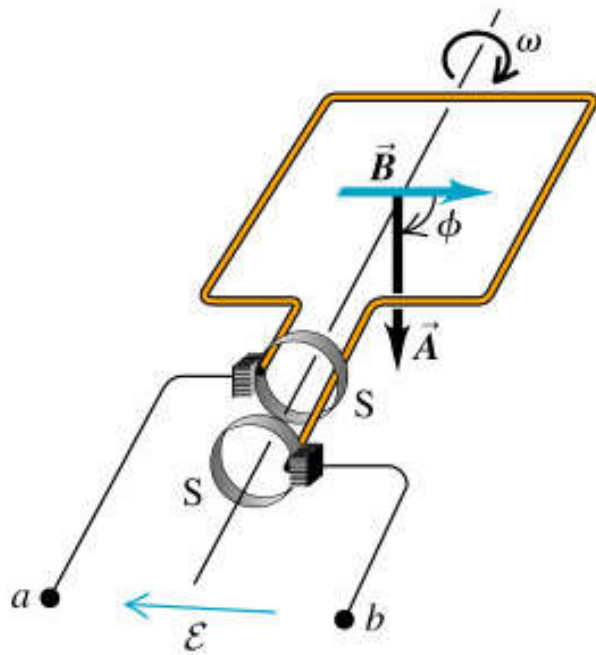

(Fig 29.8)

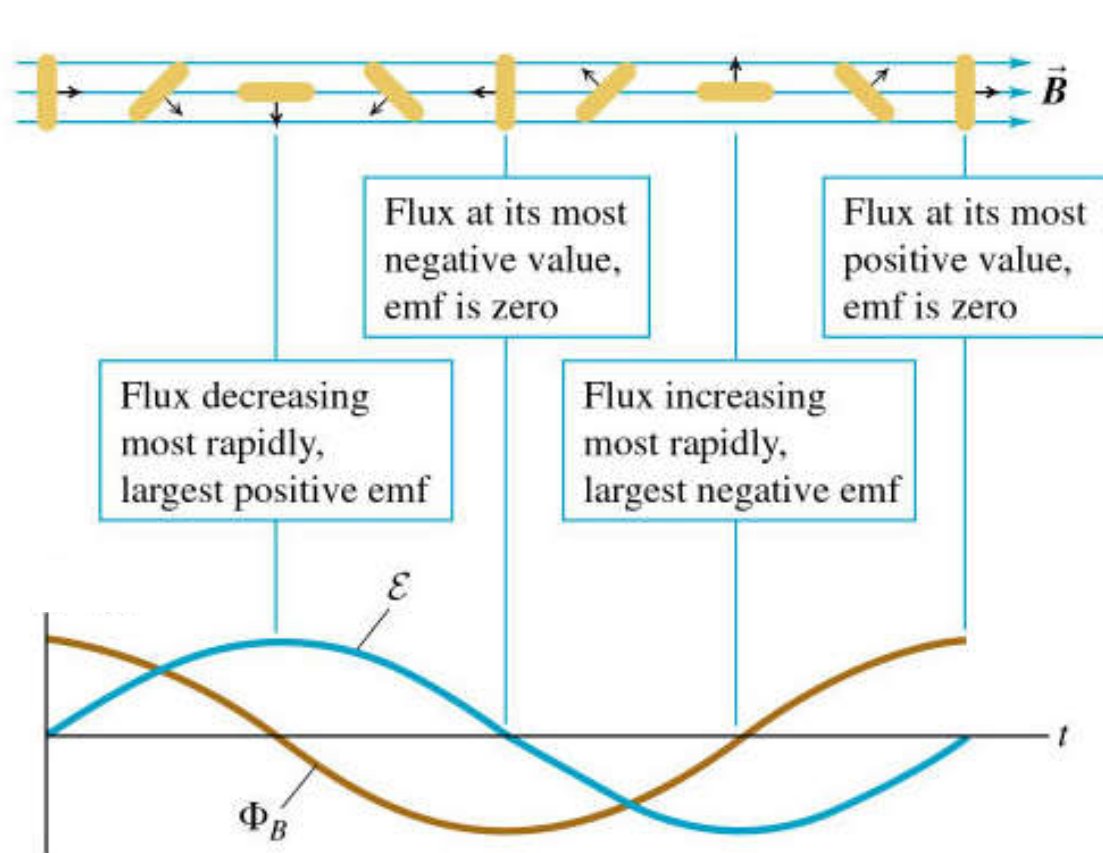

Faradays lov:

3. Endring $\varphi(t)$:

$$\mathcal{E} = - d\Phi_B/dt = - B \cdot A \cdot d(\cos \varphi) /dt$$

Med kommutator
(likeretter)

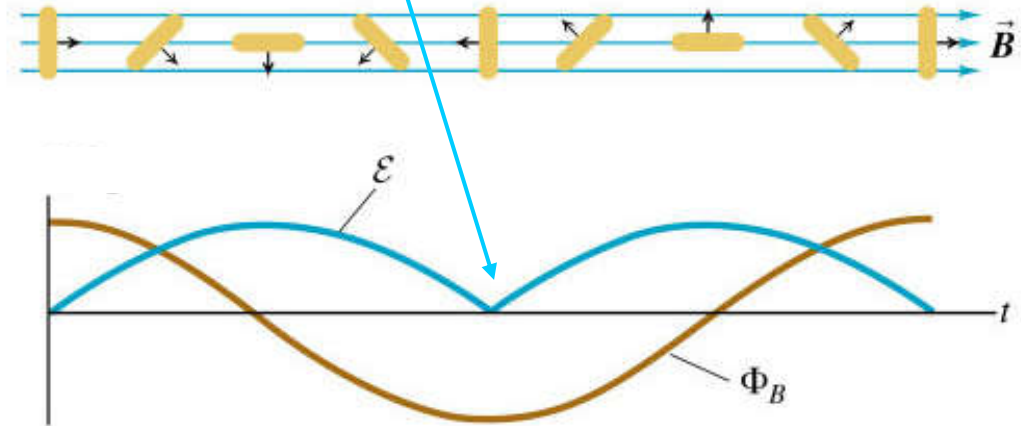
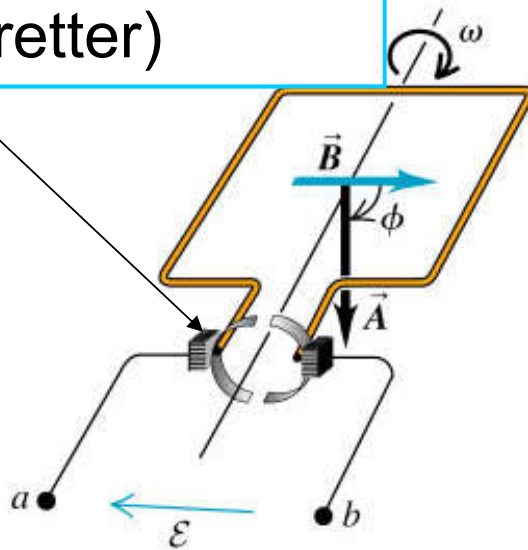

(Fig 29.10)

Kap. 29: Oppsummering: Elektromagnetisk induksjon

Faradays lov for homogent \mathbf{B} -felt og plan strømsløyfe:

$$\mathcal{E} = - d\Phi_B/dt = - d/dt \{ B(t) \cdot A(t) \cdot \cos\varphi(t) \}$$

Tre ulike tilfeller:

1) Bevegelsesindusert, endring i $A(t)$:

$$\mathcal{E} = - d\Phi_B/dt = - B \cdot dA(t)/dt \cdot \cos 0^\circ$$

2) Tidsvariasjon i $B(t)$:

$$\mathcal{E} = - d\Phi_B/dt = - dB(t)/dt \cdot A \cdot \cos 0^\circ$$

3) Rotasjon, endring i $\varphi(t)$:

$$\mathcal{E} = - d\Phi_B/dt = - B \cdot A \cdot d(\cos \varphi) / dt$$

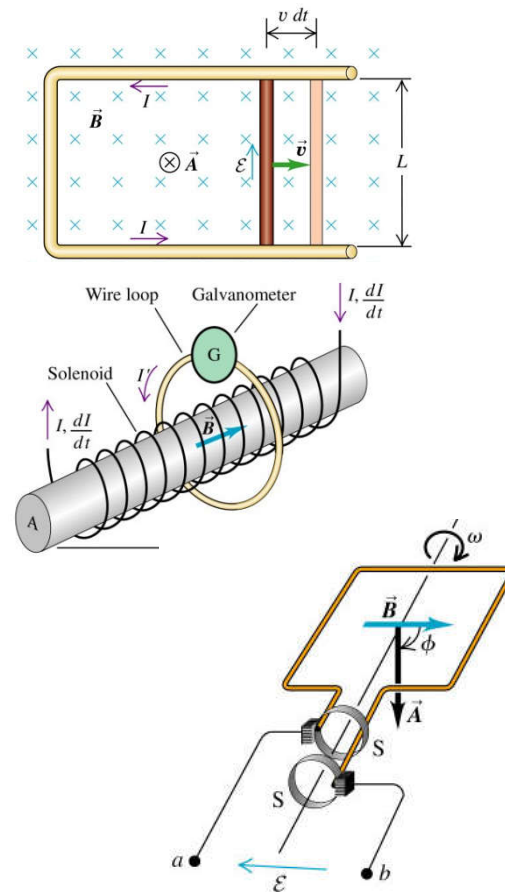

Faradays lov:

1. Endring $A(t)$:

$$\mathcal{E} = - d\Phi_B/dt = - B \cdot dA(t)/dt \cdot \cos 0^\circ$$

Arbeid å flytte tverrstaven

Mekanisk arbeid = elektrisk dissipert energi i R

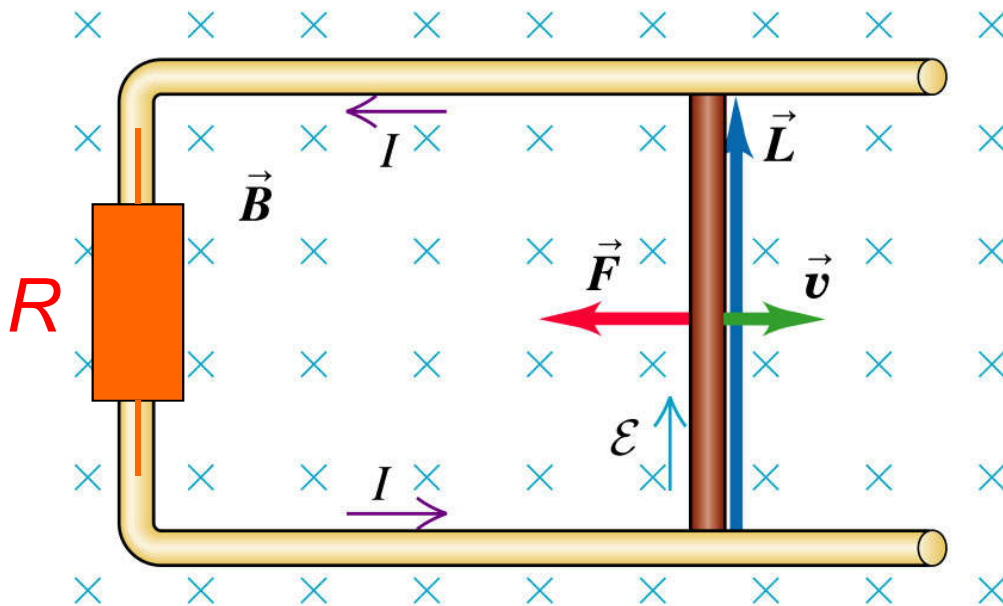

$$I = \mathcal{E} / R = B l v / R$$

$$F = I l B = B^2 l^2 v / R$$

Effekt:

$$P = Fv = B^2 l^2 v^2 / R$$

Kap 29: Elektromagnetisk induksjon

- Faradays lov og Lenz' lov (29.1-5)
- Virvelstrømmer (29.6)
- Forskyvningsstrøm (29.7)
- Superledende materiale

Virvelstrømmer

Eks: B -felt over en del av arealet i roterende metallskive.

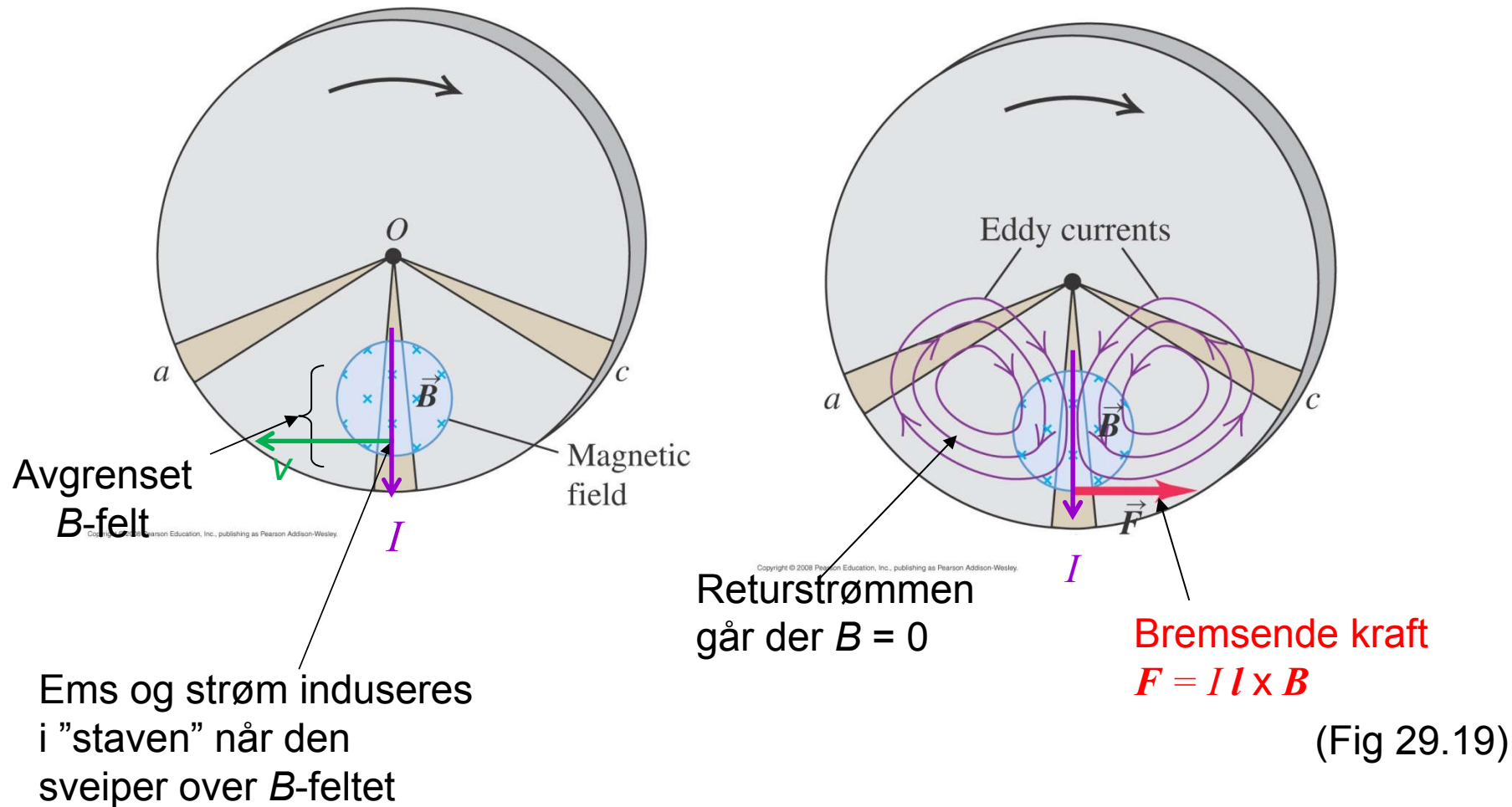

Virvelstrømmer (Y&F 29.6, ikke pensum)

Anvendelser:



- Metalldetektor:

- Minesøking
- Sikkerhetskontroll flyplasser
- Søke etter vannrør
- Deteksjon foran lyskryss
- Søppelsortering (glass/metall)

- Bremses

- tog, trikk, buss, sirkelsag, pendelsvingning
(virvelstrøm gir varme, evt. induksjonsbrems gii)

- Wattmålere (strøm fra E-verk)

- Fartsmålere bil (tidligere, nå: digitalt eller GPS)

- Induksjonskomfyrer

høyfrekvent strøm og ferromagnetisk materiale

=> liten inntrengingsdybde og stor resistans, samt stor B

- Induksjonssveising.

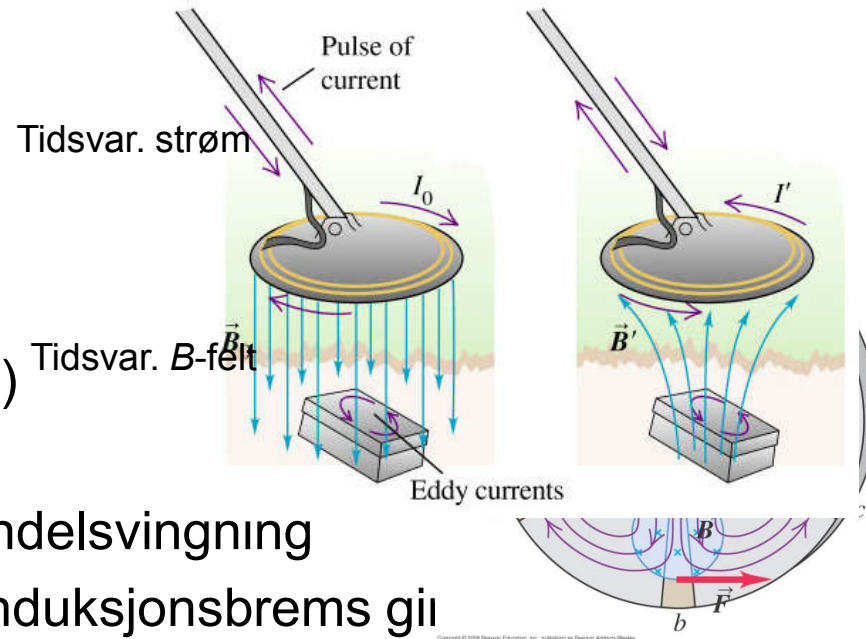

”Eddy current pendulum”

Video på nettside <http://demoroom.physics.ncsu.edu/html/demos/163.html>



Virvelstrøm i Lenz' rør
(tidsvarierende $B(t)$ fra
bevegende magnet)

Ring =
del av røret

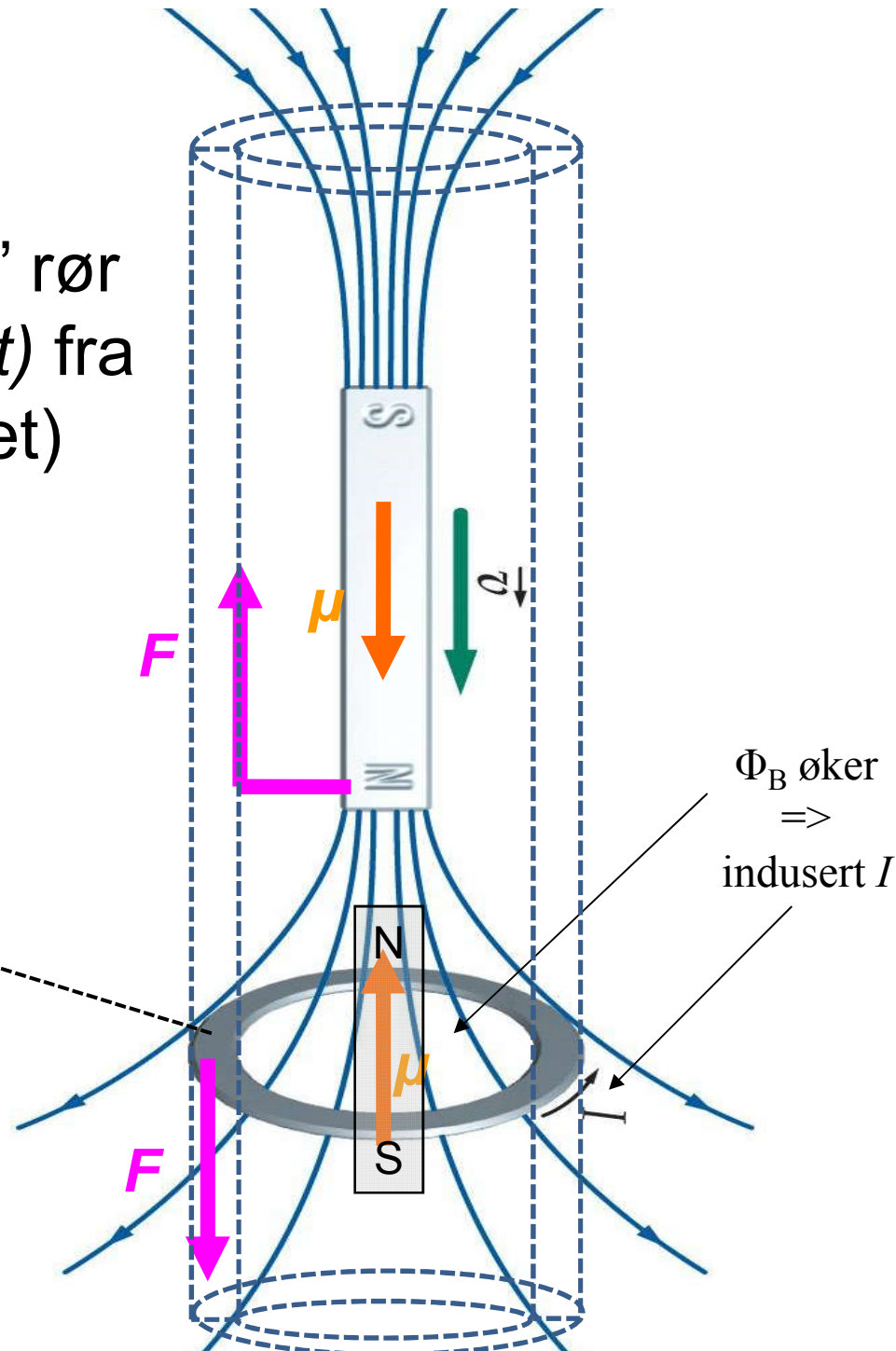

Lenz' rør

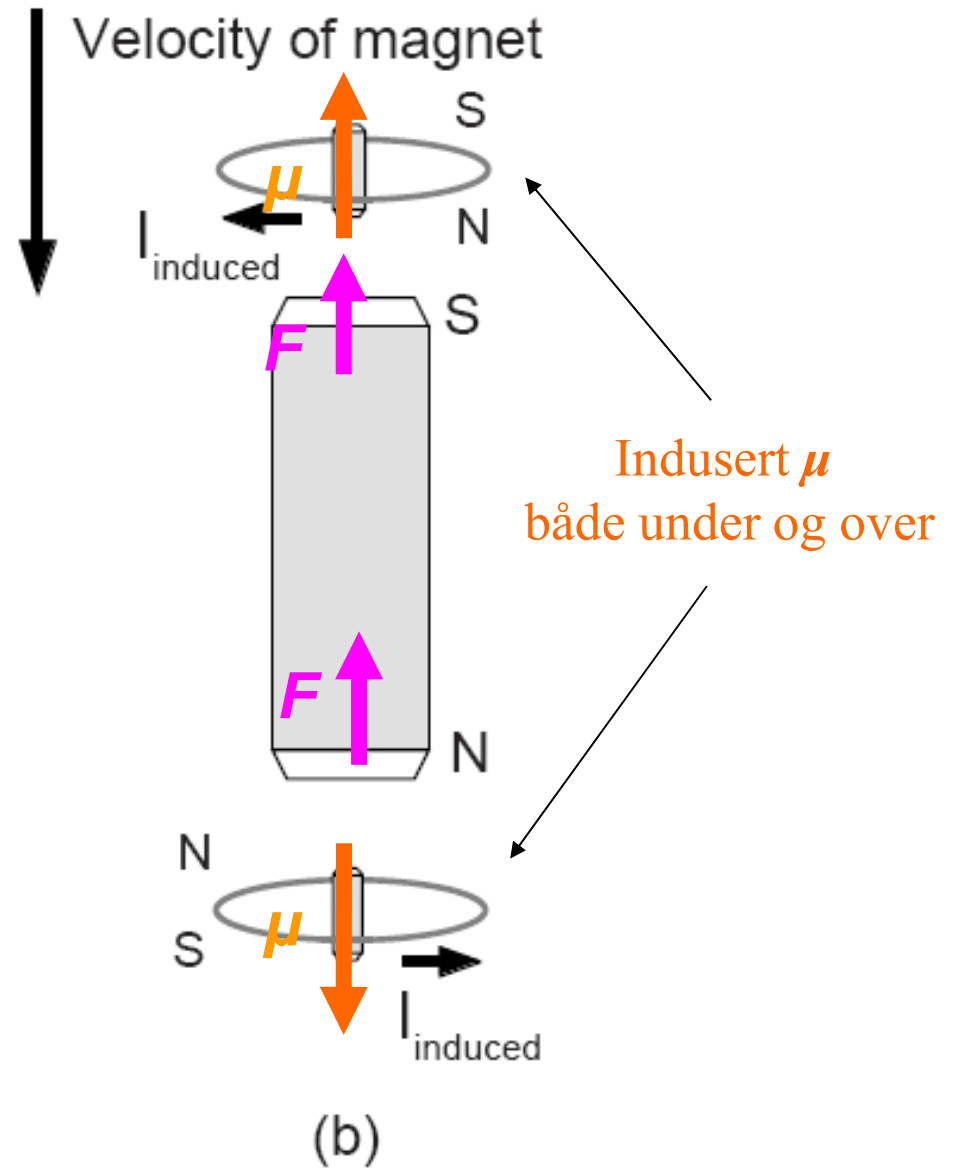
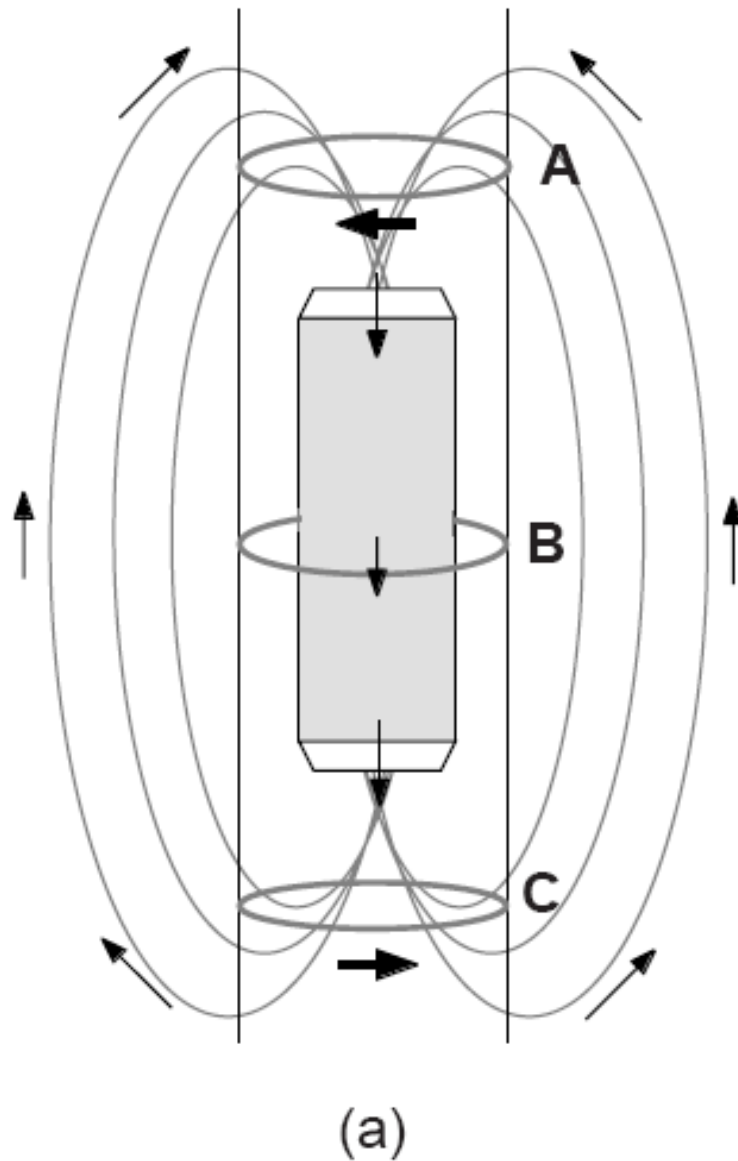

Eks: B -felt over hele arealet i roterende metallskive.

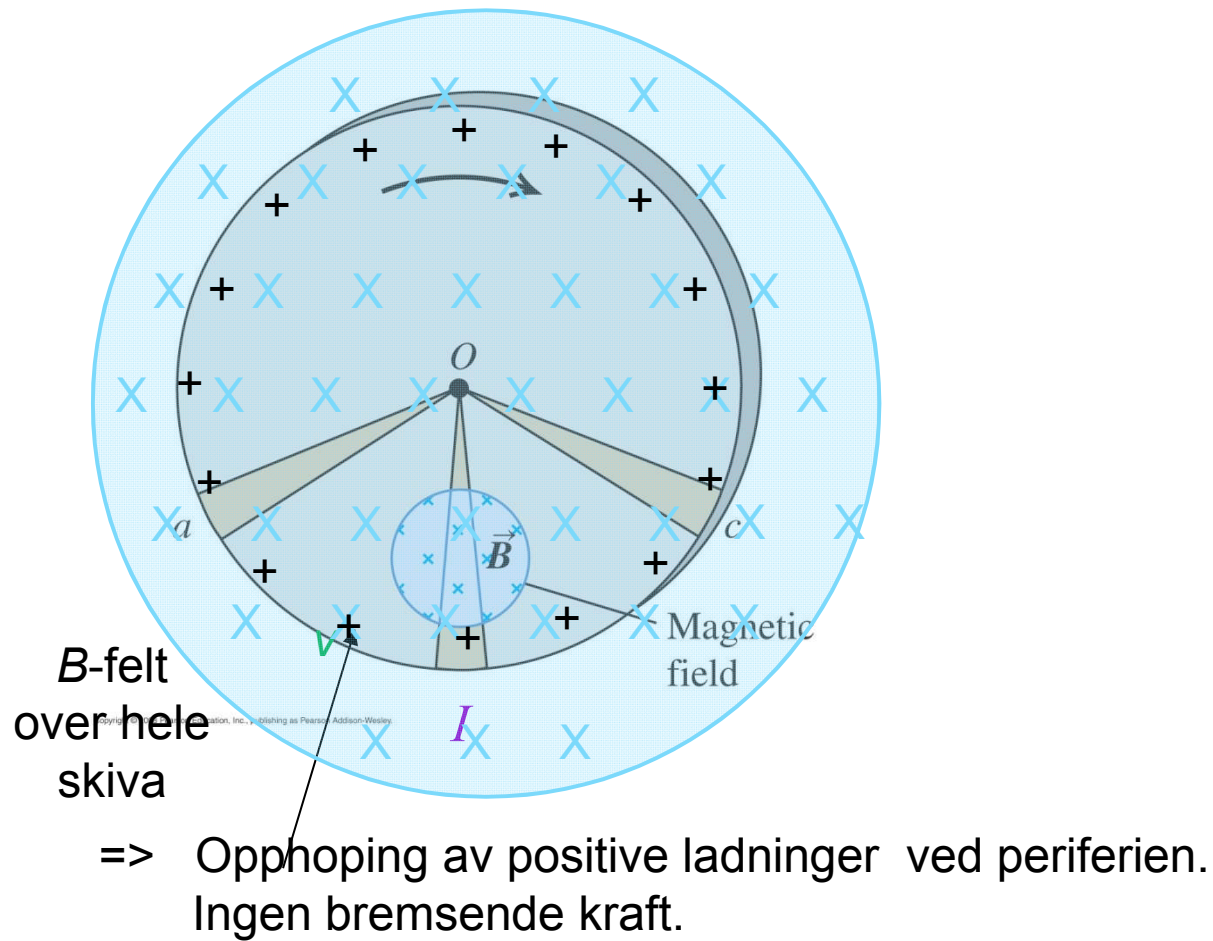

Kap 29: Elektromagnetisk induksjon

- Faradays lov og Lenz' lov (29.1-5) $B(t) \rightarrow E(t)$
- Virvelstrømmer (29.6)
- Forskyvningsstrøm (29.7) $E(t) \rightarrow B(t)$
- Superledende materiale

Maxwells likninger i Notat 4

Integralform

$$\oint \vec{D} \cdot d\vec{A} = Q \quad \boxed{\text{Gauss' lov } \mathbf{D}}$$

$$\oint \vec{B} \cdot d\vec{A} = 0 \quad \boxed{\text{Gauss' lov } \mathbf{B}}$$

$$\oint \vec{H} \cdot d\vec{\ell} = I + \frac{\partial \Phi}{\partial t} \quad \boxed{\text{Amperes lov}}$$

$$\oint \vec{E} \cdot d\vec{\ell} = 0 - \frac{\partial \Phi_B}{\partial t} \quad \boxed{\text{Faradays lov}}$$

Differensialform

$$\vec{\nabla} \cdot \vec{D} = \rho$$

$$\vec{\nabla} \cdot \vec{B} = 0$$

$$\vec{\nabla} \times \vec{H} = \vec{J} + \frac{\partial \vec{D}}{\partial t}$$

$$\vec{\nabla} \times \vec{E} = 0 - \frac{\partial \vec{B}}{\partial t}$$

Problem med Amperes lov?

$$\int_{\Gamma} \mathbf{H} \cdot d\mathbf{s} = i_{\text{encl}}$$

= strøm gjennom enhver valgt flate omhyllet av intgrasjonsvegen Γ

Plan flate A med omhyllingskurve= Γ : strøm i_C gjennom flata

Kurvet flate B med omhyllingskurve= Γ : ingen strøm gjennom flata!

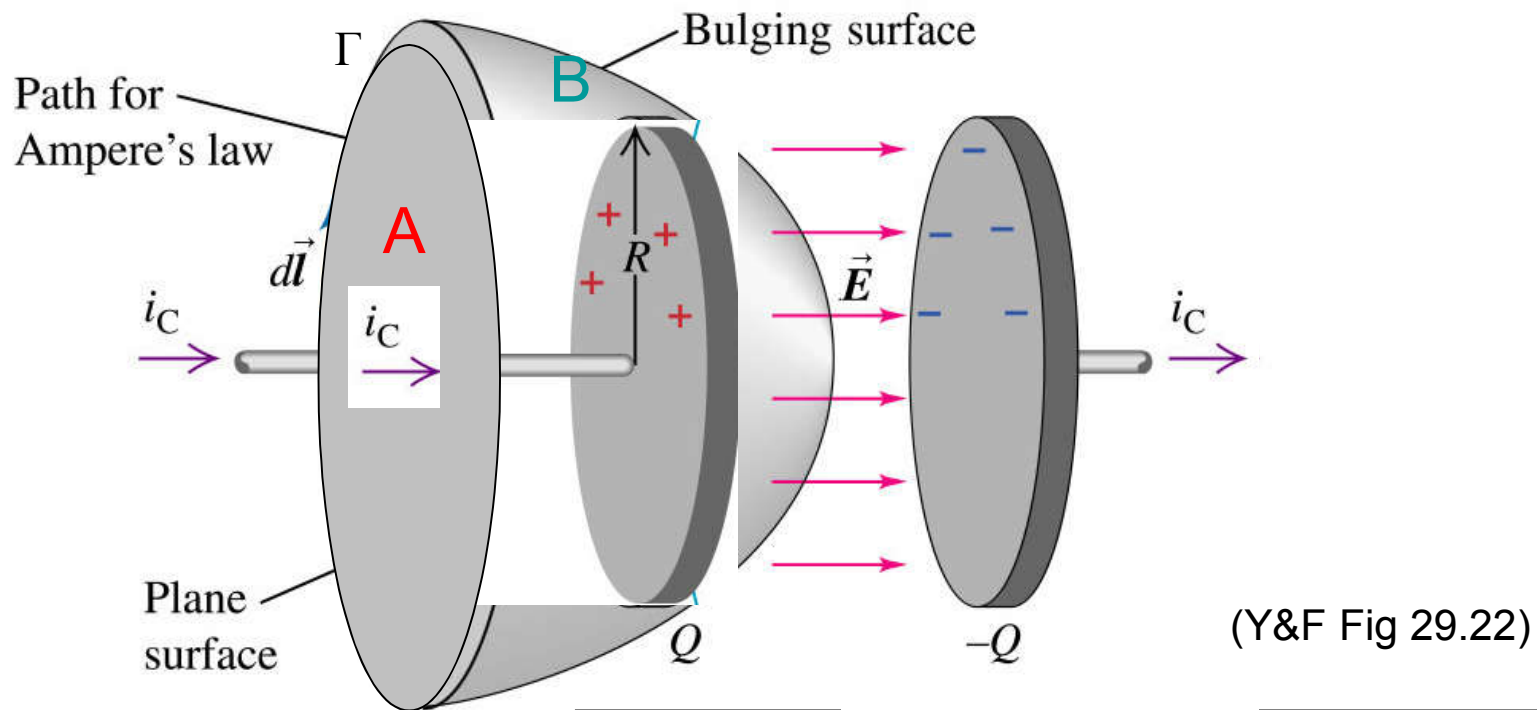

Løsning: "Forskyvningsstrøm"

Forskyvningsstrøm:

$$I_d = d\Phi/dt, \quad \text{der}$$

$$\Phi = \int \mathbf{D} \cdot d\mathbf{A}$$

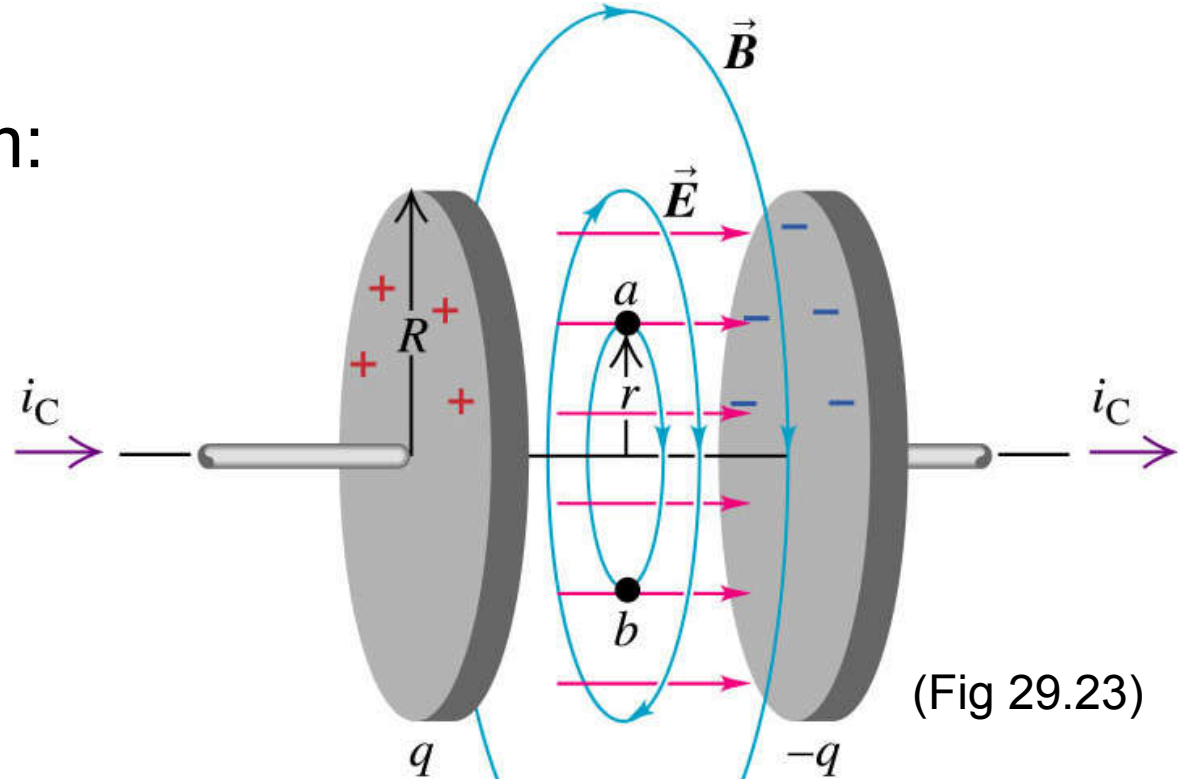

Strømmen I_C som lader kondensatoren fortsetter mellom platene som forskyvningsstrøm I_d som gir B -felt mellom platene.

Ampere-Maxwells lov:

$$\int \mathbf{B} \cdot d\mathbf{s} = \mu_0 (I + I_d)$$

$$\int \mathbf{H} \cdot d\mathbf{s} = I + I_d \quad (\text{Amp-Max})$$

Differensialform: $\text{curl } \mathbf{H} = \mathbf{J} + \partial\mathbf{D}/\partial t \quad (\text{Amp-Max-diff})$

Superledere (Y&F 29.8, ikke pensum)

1. Resistans faller brått til ≈ 0 under gitt temp T_C

	Resistivitet:
Isolatorer:	$\rho \approx 10^{14} \Omega\text{m}$
Halvledere:	$\rho \approx 1 \Omega\text{m}$
Metaller:	$\rho \approx 10^{-7} \Omega\text{m}$
Superledere:	$\rho < 10^{-20} \Omega\text{m}$

- 1911: H Kammerlingh Onnes: Kvikksølv under $T_C = 4,1 \text{ K}$
(Nobelpris fysikk 1913)
- 1957: BCS-teori (J Bardeen, LN Cooper, JR Schrieffer):
Kvantemekanisk forklaring. (Nobelpris fysikk 1972)
- 1986: J. Bednorz, KA Müller: Visse oksider:
superledning opp til $T_C \approx 100 \text{ K}$.
(Flytende N_2 har temp 77 K.) (Nobelpris fysikk 1987)

Metaller T_c (K)

Al	1.18
In	3.41
Sn	3.72
Ta	4.47
V	5.40
Pb	7.20
Nb	9.25
Hg	4.12
Ga	1.07

Legeringer og sammensetninger

Pb–In	7
Pb–Bi	8.3
Nb–Ti	9.5
Nb–Zr	10.7
Nb–N	16.0
V ₃ Ge	15.3
V ₃ Si	16.3
Nb ₃ Sn	18.0
Nb ₃ Ge	23.2

Kritiske temperaturer for superledere

(Flytende N₂ har temp 77 K.)

Oksider

BaPb _{0.75} B _{0.25} O ₃	13
La _{1.85} Ba _{0.15} CuO ₄	36
Bi ₂ Sr ₂ CaCu ₂ O ₈	84
Tl ₂ Ba ₂ Ca ₂ Cu ₃ O ₁₀	125

Fullerener

K ₃ C ₆₀	18
Rb ₃ C ₆₀	28
Cs ₂ RbC ₆₀	33

(Tab. 21.4 i Lillestøl, Hunderi, Lien)

Superledere

2. Magnetfelt trekker ikke inn i superledere, $B = \mu_r \mu_0 H = 0$ inni.

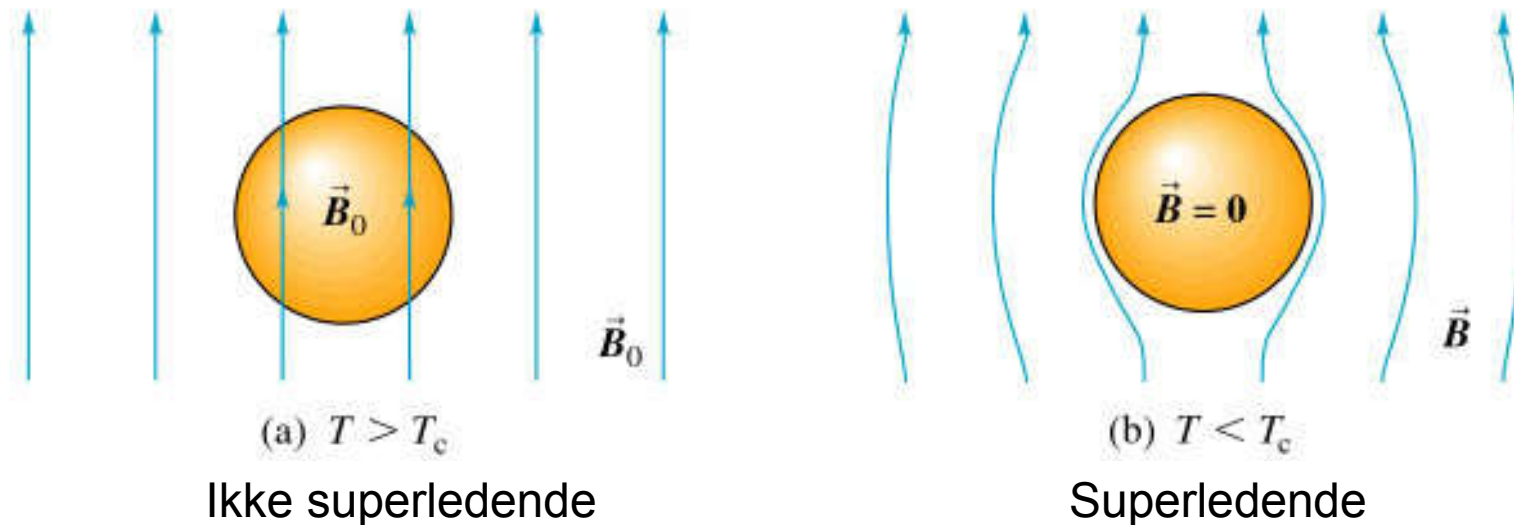

dvs. superledere er perfekt diamagnetisk:

(Fig 29.26)

$$\chi_m = -1 \quad \mu_r = 0$$

(Meissnereffekt)

Jern tiltrekkes både S-pol og N-pol (i inhomogent felt).

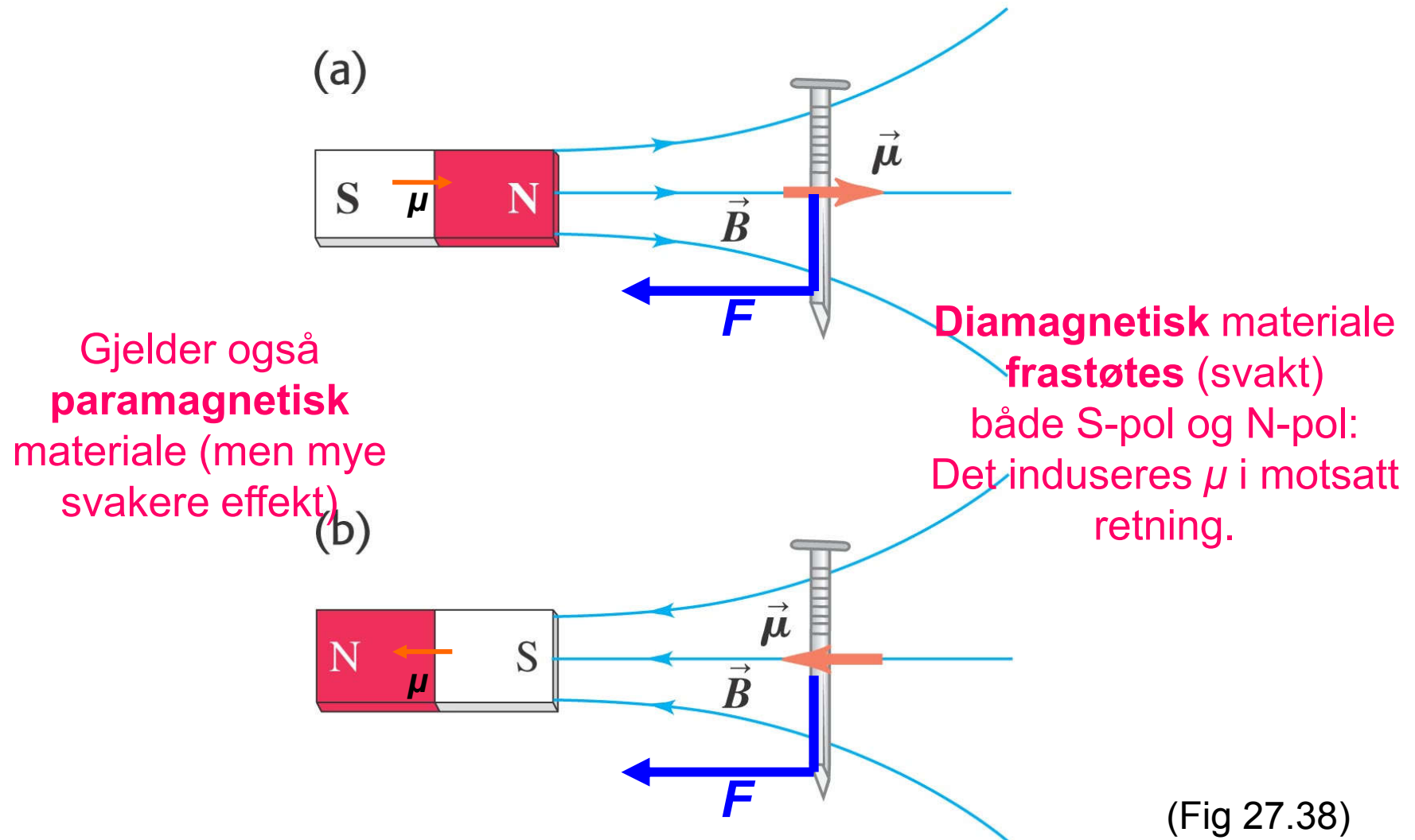

Magnetisk levitasjon

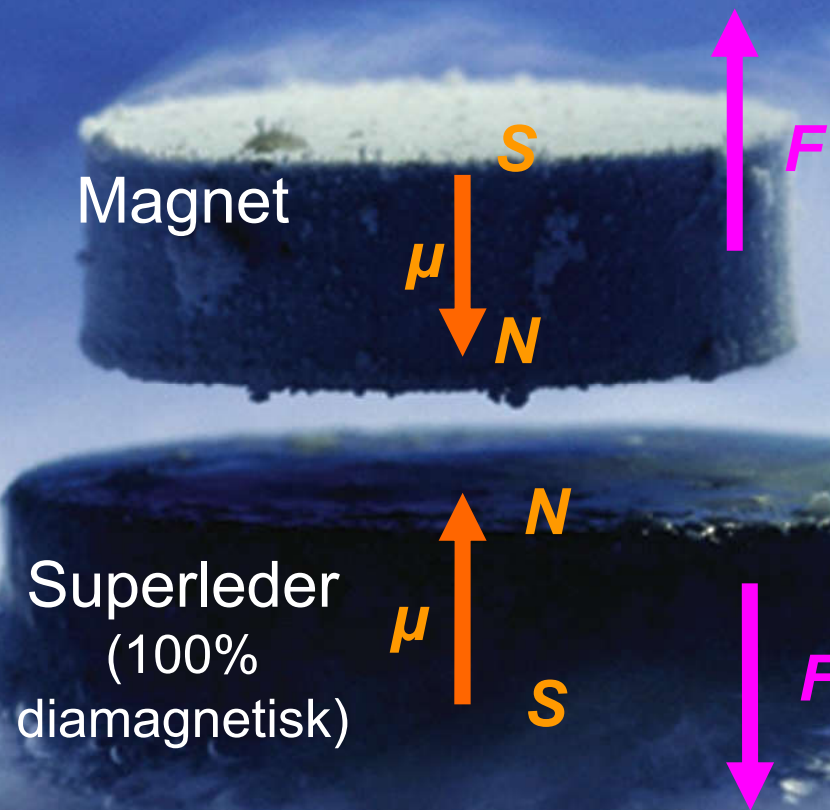

Demo: <http://www.youtube.com/watch?v=nWTSzBWEsms>

Materiale			Magnet
ferromagnetisk	$\chi_m \gg 1$	$\mu_r \gg 1$	tiltrekkes sterkt
paramagnetisk	$\chi_m \approx > 0$	$\mu_r \approx 1^+$	tiltrekkes svakt
diamagnetisk	$\chi_m \approx < 0$	$\mu_r \approx 1^-$	frastøtes svakt
superleder	$\chi_m = -1$	$\mu_r \approx 0$	frastøtes sterkt

Demo av vann som diamagnetisk materiale:

<http://www.youtube.com/watch?v=jyqOTJOJSoU>

EDS = Electrodynamisk suspensjon:
Superledende magneter i toget,
induserte magneter i skinnegangen.

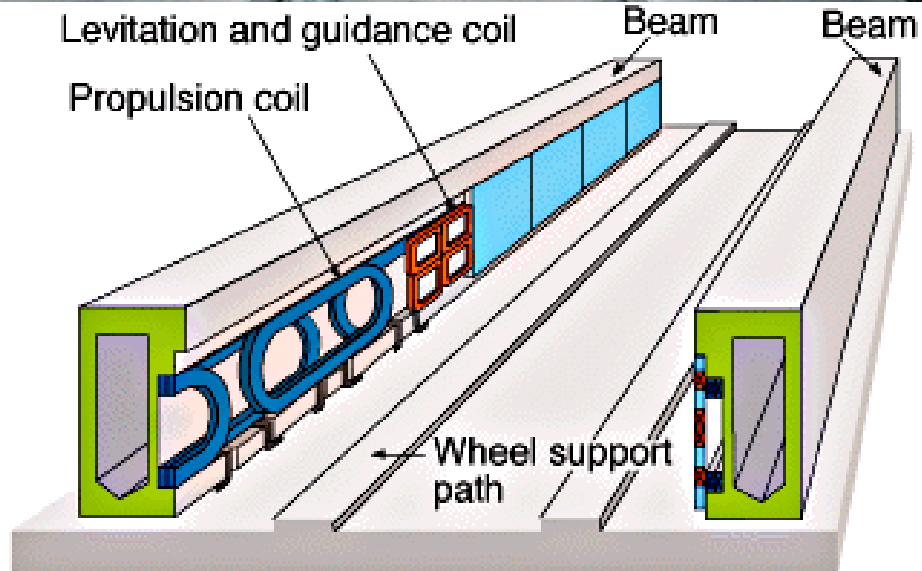

EDS = Electrodynamisk suspensjon

Levitasjon og sidestabilisering

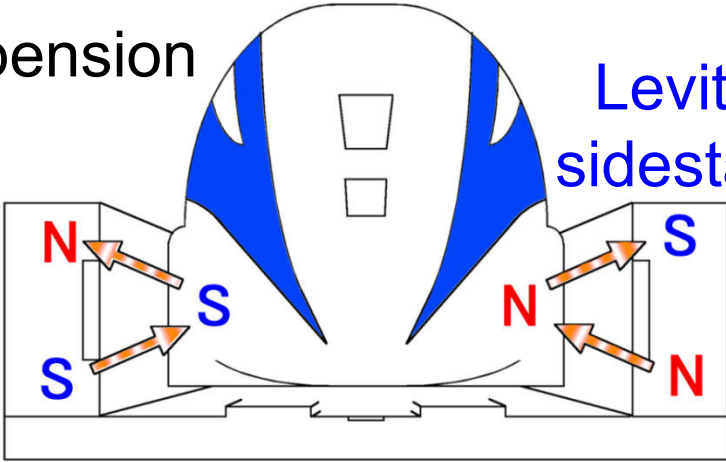
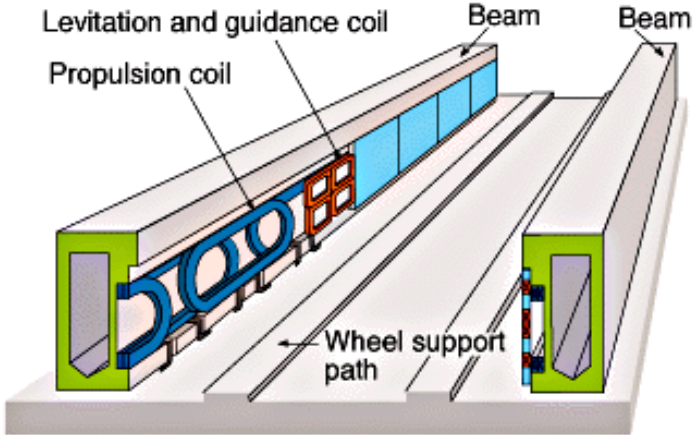

Framdrift

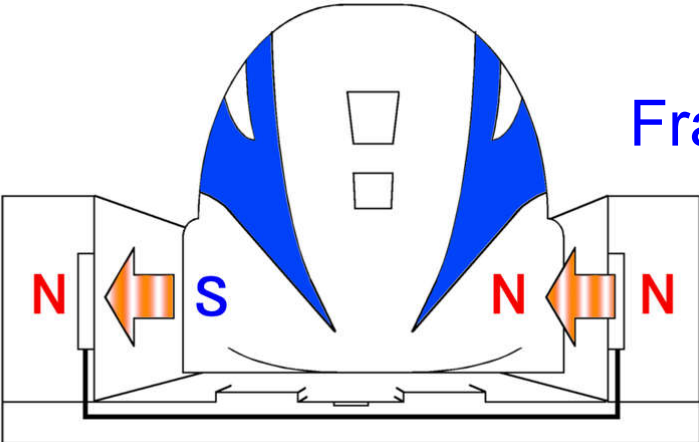

Maglev-leiketøystog:
Se: [Simuleringside](#)

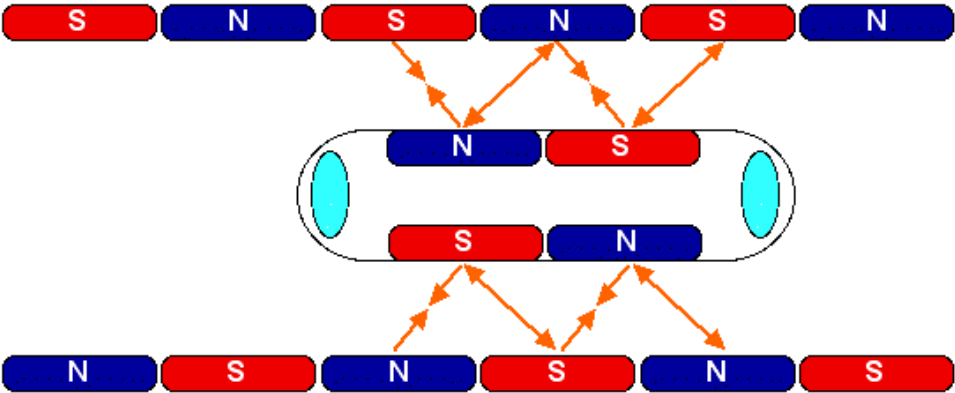

Praktisk nytte av superledere:

- Produksjon av sterke B -felt (> 1 T):
 - MR-instrument i medisin og
 - NMR-instrument i vitenskapen
 - I noen Maglev-tog (magnet-svevetog):
 - <https://en.wikipedia.org/wiki/SCMaglev>
 - <https://en.wikipedia.org/wiki/Maglev>
- Elektrisk kraftoverføring?
Forsøk på gang (korte strekninger).

Kap. 29: Oppsummering: Elektromagnetisk induksjon

- Faradays lov for homogent \mathbf{B} -felt og plan strømsløyfe:

$$\mathcal{E} = - d\Phi_B/dt = - d/dt \{ B(t) \cdot A(t) \cdot \cos\varphi(t) \}$$

- Faradays lov for homogent \mathbf{B} -felt og plan strømsløyfe:
Tre ulike tilfeller:

- 1) Bevegelsesindusert, endring i $A(t)$:

$$\mathcal{E} = - d\Phi_B/dt = - B \cdot dA(t)/dt \cdot \cos 0^\circ$$

- 2) Tidsvariasjon i $B(t)$:

$$\mathcal{E} = - d\Phi_B/dt = - dB(t)/dt \cdot A \cdot \cos 0^\circ$$

- 3) Rotasjon, endring i $\varphi(t)$:

$$\mathcal{E} = - d\Phi_B/dt = - B \cdot A \cdot d(\cos \varphi) / dt$$

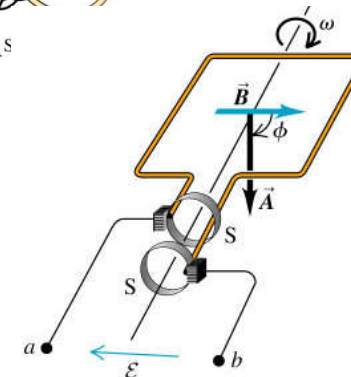
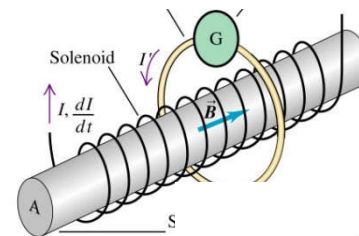
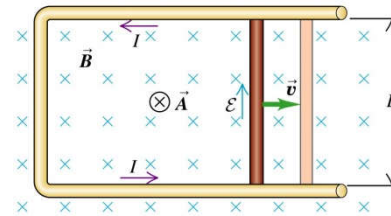

Kap. 29: Oppsummering: Elektromagnetisk induksjon

- Faradays lov:

$$\mathcal{E} = - d\Phi_B/dt, \quad \text{der } \Phi_B = \int \mathbf{B} \cdot d\mathbf{A}.$$

Dvs: endring i magnetisk fluks Φ_B induserer ems.

Generelt, induksjon av \mathbf{E} -felt i lukket kurve:

$$\int \mathbf{E} \cdot d\mathbf{s} = \mathcal{E} = - d\Phi_B/dt$$

- Lenz' lov: Indusert strøm motsetter seg fluksendringen.
- Virvelstrømmer.
- Forskyvningsstrøm: $I_d = d\Phi/dt$, der $\Phi = \int \mathbf{D} \cdot d\mathbf{A}$.

Ampere-Maxwells lov:

$$\int \mathbf{B} \cdot d\mathbf{s} = \mu_0 (I + I_d)$$

$$\int \mathbf{H} \cdot d\mathbf{s} = I + I_d$$

Differensialform: $\text{curl } \mathbf{H} = \mathbf{J} + \partial \mathbf{D} / \partial t$

Kap. 29: Oppsummering: Superledere

1. Resistans faller brått til ≈ 0 under gitt temp T_C

Resistivitet:

Isolatorer: $\rho \approx 10^{14} \Omega\text{m}$

Halvledere: $\rho \approx 1 \Omega\text{m}$

Metaller: $\rho \approx 10^{-7} \Omega\text{m}$

Superledere: $\rho < 10^{-20} \Omega\text{m}$

2. Perfekt diamagnetisk: $\chi_m = -1$, $\mu_r = 0$ ved rimelig svake magnetfelt.
 $B=0$ inni superledere (meissnereffekt).
Sterk frastøtning av magneter.

Maxwells fire likninger

Integralform

$$(1) \oint \vec{D} \cdot d\vec{A} = Q \quad \boxed{\text{Gauss' lov } \mathbf{D}}$$

$$(2) \oint \vec{B} \cdot d\vec{A} = 0 \quad \boxed{\text{Gauss' lov } \mathbf{B}}$$

$$(3) \oint \vec{H} \cdot d\vec{\ell} = I + \frac{\partial \Phi}{\partial t} \quad \boxed{\text{Amperes lov}}$$

$$(4) \oint \vec{E} \cdot d\vec{\ell} = -\frac{\partial \Phi_B}{\partial t} \quad \boxed{\text{Faradays lov}}$$

Differensialform

$$\vec{\nabla} \cdot \vec{D} = \rho$$

$$\vec{\nabla} \cdot \vec{B} = 0$$

$$\vec{\nabla} \times \vec{H} = \vec{J} + \frac{\partial \vec{D}}{\partial t}$$

$$\vec{\nabla} \times \vec{E} = -\frac{\partial \vec{B}}{\partial t},$$

Elmagsirkelen

og Maxwelllikningene

$$(4) \oint \vec{E} \cdot d\vec{\ell} = -\frac{\partial \Phi_B}{\partial t}$$

(Faraday)
- $\partial/\partial t$

q
(Coulomb)
(Gauss)

$$\oint \vec{E} \cdot d\vec{A} = \frac{Q}{\epsilon_0} \quad (1)$$

$$\Phi_B = \iint \mathbf{B} \, d\mathbf{A}$$

E

$$B = \mu H$$

$$D = \epsilon E$$

$$\oint \vec{B} \cdot d\vec{A} = 0 \quad (2)$$

$$\Phi = \iint \mathbf{D} \, d\mathbf{A}$$

H

(Bio-Savart)

(Ampere)

I

$\partial/\partial t$
(utvida Ampere)

$$\oint \vec{H} \cdot d\vec{\ell} = I + \frac{\partial \Phi}{\partial t} \quad (3)$$

Stokes teorem for curl:

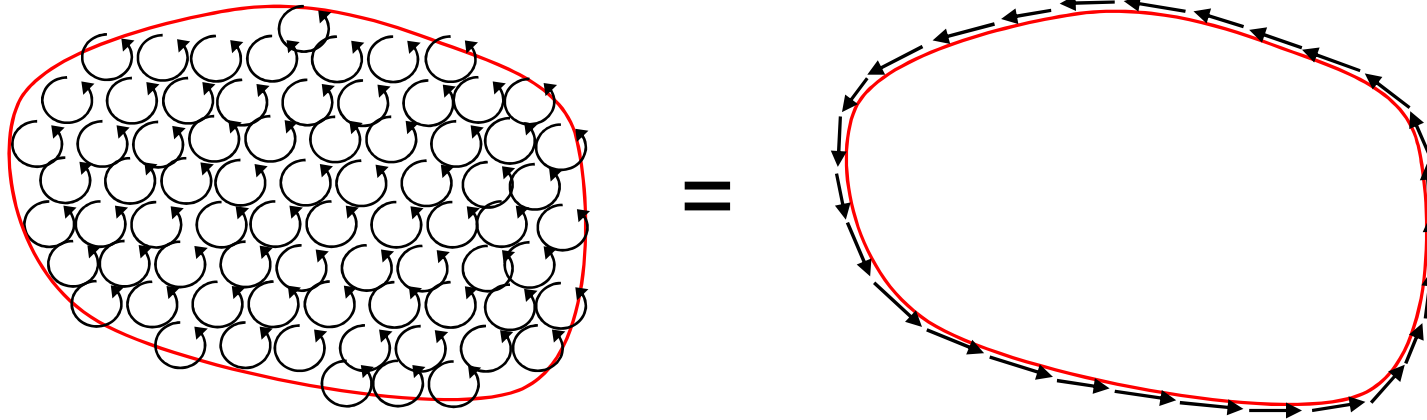

$$\iint_S \nabla \times \vec{H} \cdot d\vec{A}$$

Σ curl på flate

=

$$\oint_{\Gamma} \vec{H} \cdot d\vec{s}$$

=

sirkulasjon på omhyllingskurve

$$\nabla \times \vec{H}$$

=

$$\frac{\oint_{\Gamma} \vec{H} \cdot d\vec{s}}{d\vec{A}}$$